

5

4

3

2

1

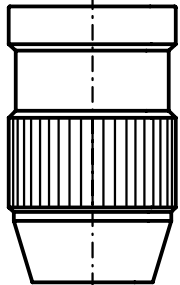
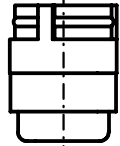
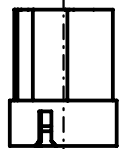
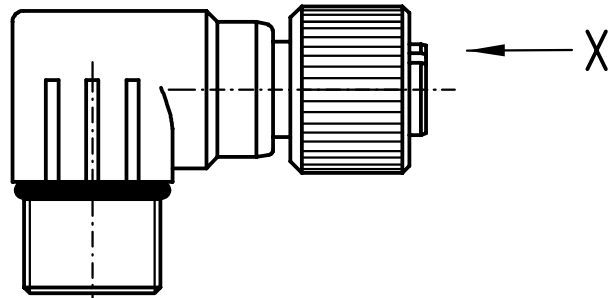

Steckgesicht n.
Contact face acc.
DIN EN 60947-5-2

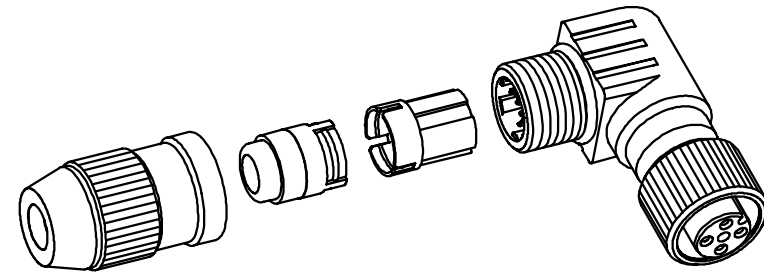
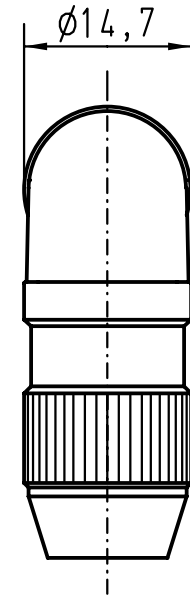
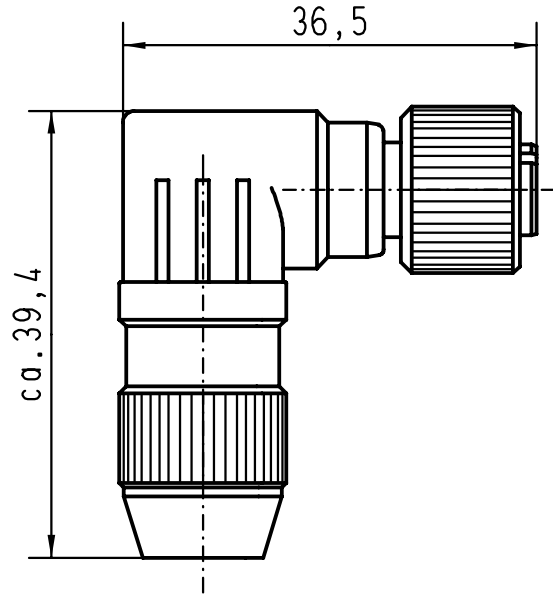
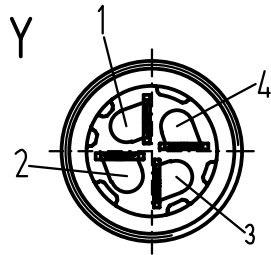
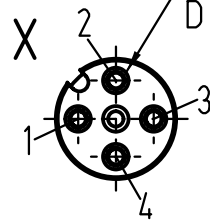

All Dimensions in mm
Original Size DIN A 4

Techn. Character.

Nicht tolerierte Maße/Free size tolerances

	Dat.	Name	Maßstab/ Scale %
Detail.	17.05.00	Pae	
Insp.	17.05.00	Well	
Stand.			

**Rundsteckverbinder/
Circular connector**
M12 gewinkelt 4polig Buchse
M12 angled 4poles female

27837

Mod. Dat. Name

HARTING KGaA
D-32339 ESPELKAMP



TB 210 114 05 091

Sub.TB 2109 003 03 02

Blatt/ page

D

C

B

A